

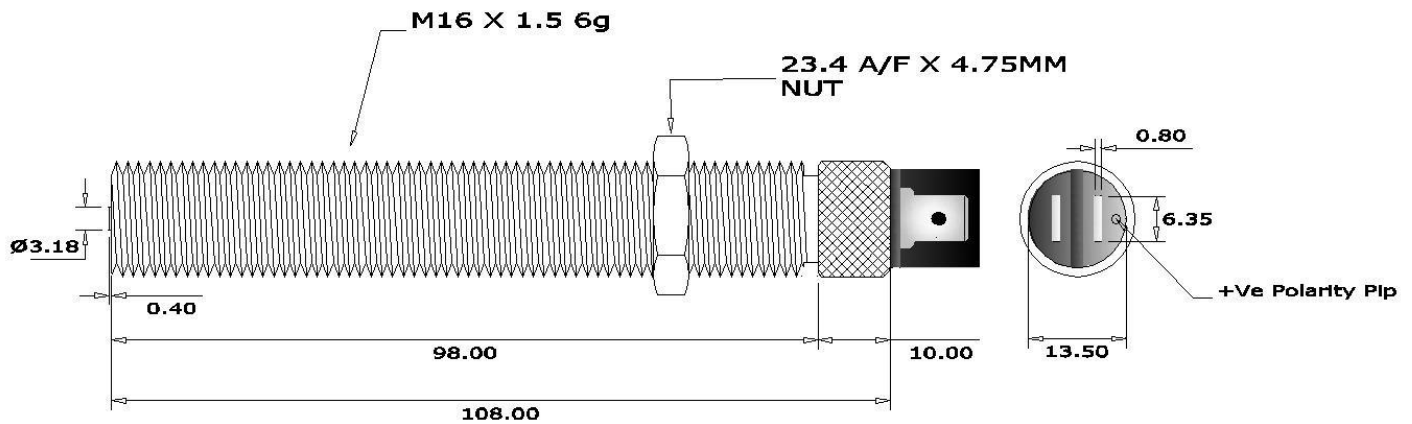

Magnetic Pick-up

B-Blade Series



Dimensions in mm unless otherwise stated

ICS Ltd Part Number: **BA-M1698-K-01**

Description: **Blade Magnetic Pick-up**

ISSUE

1.10

Body Specification

Main Body Thread: M16 X 1.5 6g
Body Material: Aluminium
Locknut: M16 X 1.5, 23.4mm AF x 4.75mm.
Locknut Material: Aluminium
Bobbin End Face Material: Polypropylene

Electrical Specification

Coil Resistance: 350 Ω ohms (+/- 10%)
Coil Inductance: 150mH (nom.)
Nominal Output: 20v peak – peak (note 1)
Minimum Speed: 30mm/sec (note 2)
Polarity: Pip terminal +Ve on approach of target

Termination & Mating Parts

Termination: 2 x (6.35mm x 0.8mm) (1/4") push-on blade
Mating Connection: 2 x (6.35mm x 0.8mm) female push-on receptacle

Operating Temperature

Main Body and Internal Parts: -54°C to +120°C

Product Details

A lightweight Aluminium bodied durable sensor, fully epoxy encapsulated with good output voltage for a wide range of applications. Customized versions, connector assemblies and accessories are available upon request.

*Note 1: Nominal output is a typical peak-peak voltage measured across a 10k ohm load using a 10DP, 60 tooth mild steel gear wheel with a diameter of 150mm rotating at 1000 rpm and with an air gap setting of 0.254mm (0.01')

*Note 2: Minimum speed in mm/second to generate 100 mV Peak-Peak output under standard test conditions as in note 1.



CERTIFICATE No : 1628/98

INSTRUMENTATION AND CONTROL SERVICES (HEREFORD) LIMITED

UNIT 3, THE OLD FORGE INDUSTRIAL ESTATE, PETERCHURCH, HEREFORD, HR2 0SD

Telephone: 01981 550011 Fax: 01981 550955

Email: ics@ics-herford.co.uk

Websites: www.ics-herford.co.uk & www.cablewireassembly.co.uk